

USER GUIDE

Solar Inverter

GPEO Series(1.8KVA/3.6KVA)

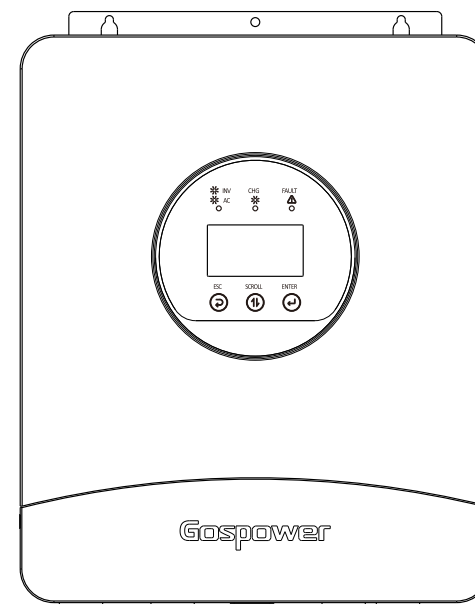

Solar inverter

Contents

ABOUT THIS MANUAL	1
Purpose.....	1
Scope.....	1
Safety instructions.....	1
WARNING MARKS	2
INTRODUCTION	3
Features	3
Basic system architecture.....	3
PRODUCT OVERVIEW	4
SPECIFICATIONS	5
INSTALLATION	8
Safety guidance	8
Unpacking and inspection	8
Preparation.....	9
Mounting the unit.....	9
Battery connection.....	10
AC input /output connection	11
PV connection.....	13
Final assembly.....	14
Wiring System for Inverter	15
OPERATION	16
Power ON/OFF.....	16
Operation and display panel.....	16
LCD display icons.....	17
LCD operation flow chart.....	19
Base information Page.....	19
Setting Page	21
BMS information Page.....	25
Rated information Page	26
Lithium Battery Communication.....	27
WARNING CODE TABLE	28
FAULT CODE TABLE	29

ABOUT THIS MANUAL

Purpose

This manual describes the assembly, installation, operation, warning code and fault code of this unit. Please read this manual carefully before installations and operations. Keep this manual for future reference.

Scope

This manual provides safety and installation guidelines as well as information on tools and wiring.

Safety instructions











WARNING: This chapter contains important safety and operating instructions. Read and keep this manual for future reference.

1. Before using the unit, read all instructions and cautionary markings on the unit, the batteries and all appropriate sections of this manual.
2. **CAUTION** --To reduce risk of injury, charge only deep-cycle lead acid type rechargeable batteries. Other types of batteries may burst, causing personal injury and damage.
3. Do not disassemble the unit. Take it to a qualified service center when service or repair is required. Incorrect re-assembly may result in a risk of electric shock or fire.
4. To reduce risk of electric shock, disconnect all wirings before attempting any maintenance or cleaning. Turning off the unit will not reduce this risk.
5. **CAUTION** – Only qualified personnel can install this device with battery.
6. **NEVER** charge a frozen battery.
7. For optimum operation of this inverter/charger, please follow required spec to select appropriate cable size. It's very important to correctly operate this inverter/charger.
8. Be very cautious when working with metal tools on or around batteries. A potential risk exists to drop a tool to spark or short circuit batteries or other electrical parts and could cause an explosion.
9. Please strictly follow installation procedure when you want to disconnect AC or DC terminals. Please refer to INSTALLATION section of this manual for the details.
10. Fuse is provided as over-current protection for the battery supply.
11. **GROUNDING INSTRUCTIONS** -This inverter/charger should be connected to a permanent grounded wiring system. Be sure to comply with local requirements and regulation to install this inverter.
12. **NEVER** cause AC output and DC input short circuited. Do NOT connect to the mains when DC input short circuits.
13. **Warning!!** Only qualified service persons are able to service this device. If errors still persist after following troubleshooting table, please send this inverter/charger back to local dealer or service center for maintenance.

WARNING MARKS

Warning marks inform users of conditions which can cause serious physical injury or death, or damage to the device. They also tell users how to prevent the dangers. The warning marks used in this operation manual are shown below:

Mark	Name	Instruction	Abbreviation
 Danger	Danger	Serious physical injury or even death may occur if not follow relevant requirements.	
 Warning	Warning	Physical injury or damage to the device may occur if not follow relevant requirements.	
 Forbid	Electrostatic sensitive	Damage may occur if relevant requirements are not followed.	
 Hot	High temperature	Do not touch the base of the inverter as it will become hot.	
Note	Note	The procedures taken for ensuring proper operation.	Note

INTRODUCTION

This is a multi-function inverter/charger, combining functions of inverter, MPPT solar charger and battery charger to offer uninterruptible power support with portable size. Its comprehensive LCD display offers user-configurable and easy-accessible button operation such as battery charging current, AC/solar charger priority, and acceptable input voltage based on different applications.

Features

- Pure sine wave inverter
- Built-in MPPT solar charge controller
- Configurable input voltage range for home appliances and personal computers via LCD setting
- Configurable battery charging current based on applications via LCD setting
- Configurable AC/Solar Charger priority via LCD setting
- Compatible to mains voltage or generator power
- Auto restart while AC is recovering
- Overload / Over temperature/ short circuit protection
- Lithium battery activation function
- Cold start function
- Intelligent fan control greatly reduces fan noise

Basic System Architecture

The following illustration shows basic application for this inverter/charger. It also includes following devices to have a complete running system:

- Generator or Utility.
- PV modules (option)

Consult with your system integrator for other possible system architectures depending on your requirements.

This inverter can power all kinds of appliances in home or office environment, including motor-type appliances such as tube light, fan, refrigerator and air conditioner.

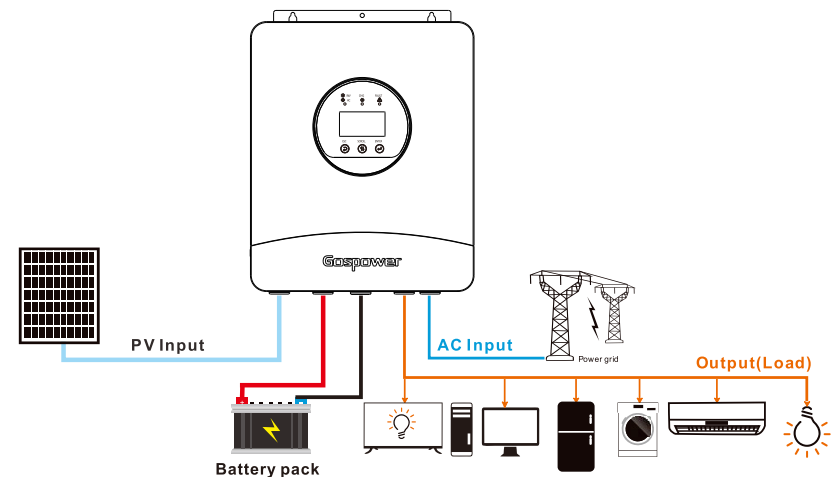

PRODUCT OVERVIEW

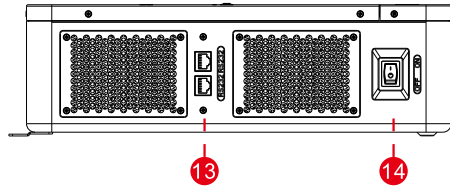
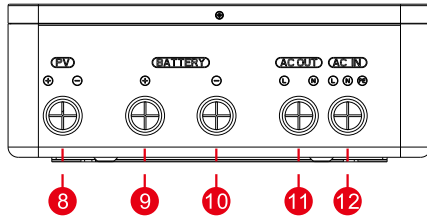
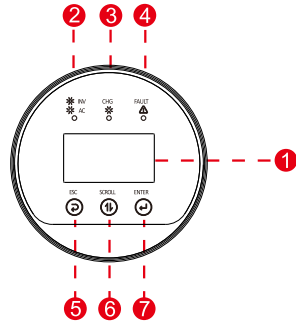
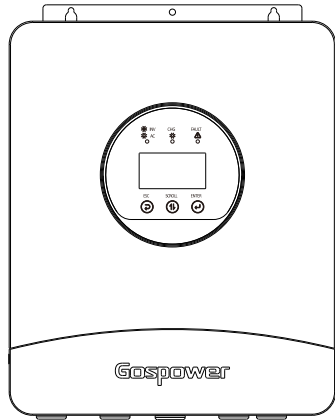

- 1. LCD display
- 2. Output indicato
- 3. Charging indicator
- 4. Fault or warning indicator
- 5. ESC button
- 6. SCALE button
- 7. Enter button
- 8. PV input connection port
- 9. Battery+ connection port
- 10. Battery- connection port
- 11. AC output port
- 12. AC input port
- 13. Communication connection port
- 14. Switch

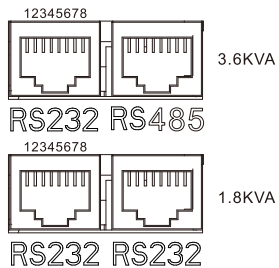

NO.	BMS	RS-232
1	NC	RS232-TXD
2	NC	RS232-RXD
3	NC	VDD12V
4	NC	VSS
5	NC	NC
6	NC	NC
7	RS485-A	NC
8	RS485-B	VSS

SPECIFICATIONS

Line Mode Specifications		
Model	GPEO-1K8L1-M	GPEO-3K6L1-M
Rated Output Power	1800VA	3600VA
	1500W	3000W
Nominal DC Input Voltage	12V	24V
Input Voltage Waveform	Sinusoidal (utility or generator)	
Nominal Input Voltage	230Vac	
Low Line Voltage Disconnect	90Vac±3V (For Home Appliances)170Vac±3V (For Computers)	
Low Loss Voltage Re-connect	100Vac±3V (For Home Appliances)180Vac±3V (For Computers)	
High Line Voltage Disconnect	280Vac±3V	
High Line Voltage Re-connect	270Vac±3V	
Max AC Input Voltage	280Vac±3V	
Nominal Input Frequency	50Hz / 60Hz (Auto detection)	
Low Line Frequency Disconnect	40±0.2Hz	
Low Line Frequency Re-connect	42±0.2Hz	
High Line Frequency Disconnect	65±0.2Hz	
High Line Frequency Re-connect	63±0.2Hz	
Output Voltage Waveform	As same as input waveform	
Output Short Circuit Protection	Line mode: Circuit Breaker Battery mode: Electronic Circuits	
Efficiency (Line Mode)	≥95% (Rated R load, battery full charged)	
Transfer Time (Single unit)	20ms	
Pass Through Without Battery	No	
Max. Bypass Overload Current	7.8A	15.6A
Max. Bypass Input Current	10A	20A
Max. Inverter/Rectifier Current	7.8A/1800VA	15.6A/3600VA

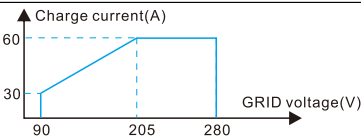
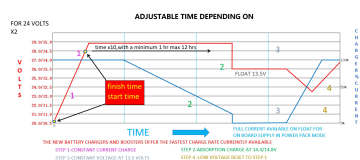
Utility Charge Mode Specifications			
Model	GPEO-1K8L1-M		GPEO-3K6L1-M
Nominal Input Voltage	230Vac		
Input Voltage Range	90-280Vac		
Nominal Output Voltage	Dependent on battery type		
Max. Grid Charge Current	60A	60A	
Charge Current Regulation	2A-60A (Adjustable unit is 1A)		
Over Charge Protection	Yes		
Grid Charging Current	<p>Relationship between battery charging current and mains voltage.</p>  <p>Charge current(A)</p> <p>GRID voltage(V)</p> <p>Battery voltage 12/24V</p>		
Solar Charging & Grid Charging			
Max. PV Open Circuit Voltage	130V	145V	
PV voltage range	15V-120V	30V-120V	
Max. Input Power	650W	1500W	
Max. Solar Charging Current	45A	60A	
Max. Charging Current(PV+Grid)	105A	120A	
Max. Input Current	20A	25A	
Min. Startup Voltage	+6V start up		
Charge Algorithm			
Algorithm	<p>Three stage: Boost CC (Constant current stage)-> Boost CV (Constant voltage stage)-> Float (Constant voltage stage)</p>		
Charging Curve			
Battery Type Setting	Battery Type	Boost CC/CV	Float
	AGM	14.1V/28.2V	13.5V/27V
	Flooded	14.5V/29.2V	13.5V/27V
	Self - defined	Adjustable, up to 14.5V/30V	
	Lithium		

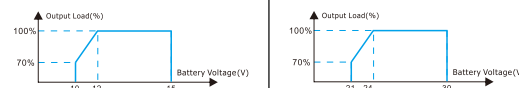
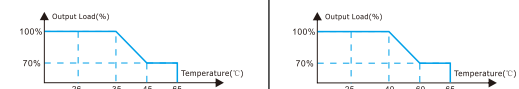
Inverter Mode Specifications		
Model	GPEO-1K8L1-M	GPEO-3K6L1-M
Rated Output Power	1800VA	3600VA
	1500W	3000W
Nominal DC Input Voltage	12V	24V
Output Voltage Waveform	Pure sine wave	
Nominal Output Voltage	230Vac±5%	
Nominal Output Frequency (Hz)	50±0.2Hz/60±0.2Hz(Adjustable)	
Parallel capability	No	
Peak Efficiency	88%	90%
Over-Load Protection (SMPS load)	2s@≥150%load;10s@105%~150%load	
Surge Rating	2* rated power for 2s	
Capable of Starting Electric	Yes	
Output Short Circuit Protection	Yes	
Cold Start Voltage	11.5V	23V
Low DC Input Shut-down @Load < 50%	10.7V	22V
@Load ≥ 50%	10.5V	21V
High DC Input Alarm & Fault	15.5V±0.2V	31V±0.2V
High DC Input Recovery	14.5V±0.2V	29V±0.2V
Battery Voltage Limitation	<p>When battery voltage is lower than 12/24Vdc, output power will be derated. The minimum AC output voltage is 180V.</p> 	
Temperature Limitation	<p>When ambient temperature is higher than 35°C/40°C, output power will be derated. The minimum AC output voltage is 180V.</p> 	
General Specifications		
Operating Temperature	-10°C~50°C	
Range Storage Temperature	-15°C~60°C	
Net Weight(KG)	5.5kG	6.0kG
Gross Weight(KG)	6.5kG	7.0kG
Product Size(D*W*H)	350x290x108mm	
Package Dimension(D*W*H)	495x385x165mm	

INSTALLATION

Safety Guidance

Warning marks inform users of conditions which can cause serious physical injury or death, or damage to the device. They also tell users how to prevent the dangers. The warning marks used in this operation manual are shown below:

	<ul style="list-style-type: none"> • After receiving this product, first confirm the product package is intact. If any question, contact the logistic company or local distributor immediately. • The installation and operation of inverter must be carried out by professional technicians who have received professional trainings and thoroughly familiar with all the contents in this manual and the safety requirements of the electrical system. • Do not carry out connection/disconnection, unpacking inspection and unit replacement operations on the inverter when power source is applied. Before wiring and inspection, users must confirm the breakers on DC and AC side of inverter are disconnected and wait for at least 5 minutes.
	<ul style="list-style-type: none"> • Ensure there is no strong electromagnetic interference caused by other electronic or electrical devices around the installation site. • Do not refit the inverter unless authorized. • All the electrical installation must conform to local and national electrical standards
	<ul style="list-style-type: none"> • Do not touch the housing of the inverter or the radiator to avoid scald as they may become hot during operation.
	<ul style="list-style-type: none"> • Ground with proper technics before operation.
	<ul style="list-style-type: none"> • Do not open the surface cover of the inverter unless authorized. The electronic components inside the inverter are electrostatic sensitive. Do take proper anti-electrostatic measures during authorized operation.
	<ul style="list-style-type: none"> • The inverter needs to be reliably grounded.
	<ul style="list-style-type: none"> • Ensure that DC and AC side circuit breakers have been disconnected and wait at least 5 minutes before wiring and checking.

Unpacking and Inspection

Before installation, please inspect the unit. Be sure that nothing inside the package is damaged. You should have received the following items inside of package:

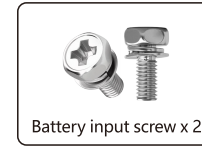
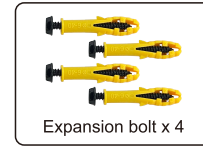
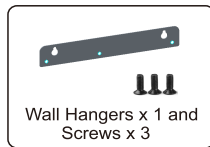
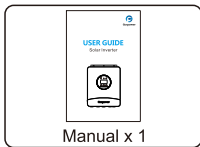
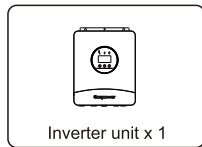

Preparation

Before connecting all wirings, please take off bottom cover by removing three screws as shown below.

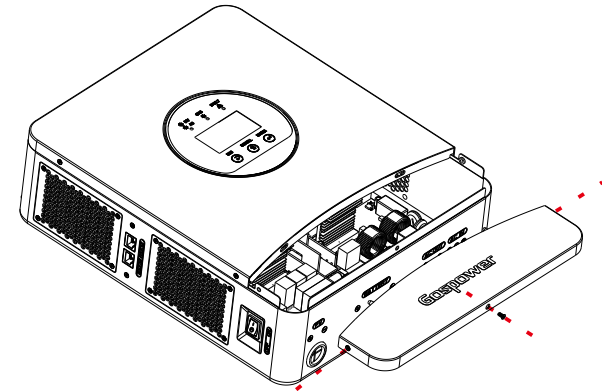

Mounting the Unit

Consider the following points before selecting where to install:

- Do not mount the inverter on flammable construction materials.
- Mount on a solid surface
- Install this inverter at eye level in order to allow the LCD display to be read at all times.
- The ambient temperature should be between -10°C and 50°C to ensure optimal operation.
- The recommended installation position is to be adhered to the wall vertically.
- Be sure to keep other objects and surfaces as shown in the right diagram to guarantee sufficient heat dissipation and to have enough space for removing wires.

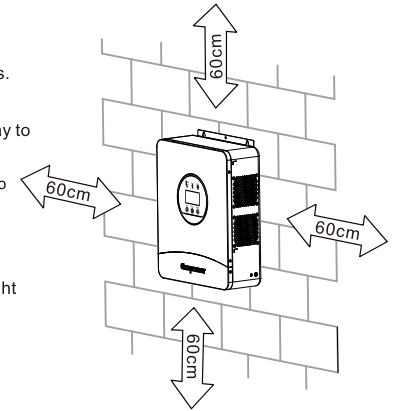

SUITABLE FOR MOUNTING ON CONCRETE OR OTHER NON-COMBUSTIBLE SURFACE ONLY.

Install the unit by screwing four screws. It's recommended to use M4 screws.

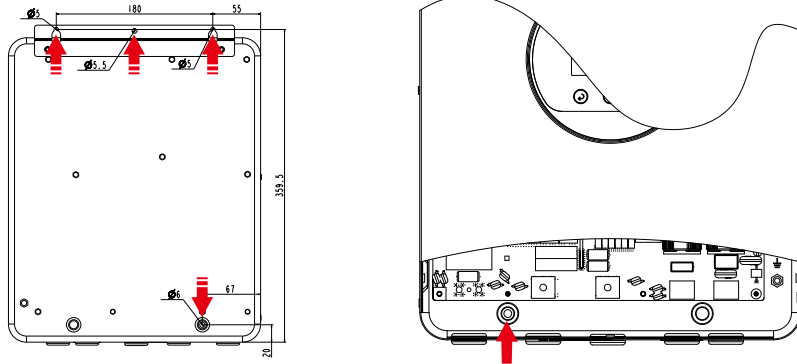

Battery Connection

CAUTION: For safety operation and regulation compliance, it's requested to install a separate DC over-current protector or disconnect device between battery and inverter. It may not be requested to have a disconnect device in some applications, however, it's still requested to have over-current protection installed. Please refer to typical amperage in below table as required fuse or breaker size.

WARNING! All wiring must be performed by a qualified personnel.

WARNING! It's very important for system safety and efficient operation to use appropriate cable for battery connection. To reduce risk of injury, please use the proper recommended cable and terminal size as below.

Recommended battery cable and terminal size:

Model	Wire Size	Cable (mm ²)	Torque Value(Max)
1.8kVA	1*2AWG	35	2 Nm
3.6kVA	1*2AWG	35	2 Nm

Please follow below steps to implement battery connection:

1. Assemble battery ring terminal based on recommended battery cable and terminal size.
2. Connect all battery packs as units requires. It's suggested to connect at least 200Ah capacity battery.
3. Insert the ring terminal of battery cable flatly into battery connector of inverter and make sure the bolts are tightened with torque of 2 Nm. Make sure polarity at both the battery and the inverter/charge is correctly connected and ring terminals are tightly screwed to the battery terminals.

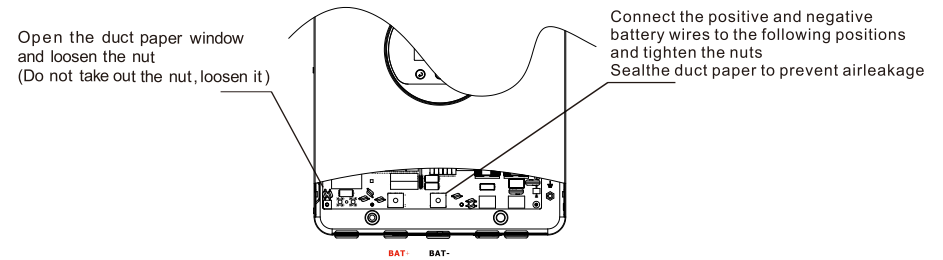

WARNING: Shock Hazard
Installation must be performed with care due to high battery voltage in series.

CAUTION!! Do not place anything between the flat part of the inverter terminal and the ring terminal. Otherwise, overheating may occur.
CAUTION!! Do not apply anti-oxidant substance on the terminals before terminals are connected tightly.
CAUTION!! Before making the final DC connection or closing DC breaker/disconnector, be sure positive (+) must be connected to positive (+) and negative (-) must be connected to negative (-).

AC Input/Output Connection

CAUTION!! Before connecting to AC input power source, please install a separate AC breaker between inverter and AC input power source. This will ensure the inverter can be securely disconnected during maintenance and fully protected from over current of AC input. The recommended spec of AC breaker is 20A for 1.8kVA and 40A for 3.6kVA.

CAUTION!! There are two terminal blocks with "IN" and "OUT" markings. Please do NOT mis-connect input and output connectors.

WARNING! All wiring must be performed by qualified personnel.

WARNING! It's very important for system safety and efficient operation to use appropriate cable for AC input connection. To reduce risk of injury, please use the proper recommended cable size as below.

Suggested cable requirement for AC wires

Model	Gauge	Cable (mm ²)	Torque Value
1.8kVA	14AWG	3	1.2Nm
3.6kVA	10AWG	6	1.2Nm

Recommended circuit breaker type for AC input:

Models	Maximum bypass input current	Recommended circuit breaker
1.8kVA	10A	2P-20A
3.6kVA	20A	2P-40A

Please follow below steps to implement AC input/output connection:

1. Before making AC input/output connection, be sure to open DC protector or disconnecter first.
2. Remove insulation sleeve 10mm for six conductors. And shorten phase L and neutral conductor N 3 mm.

3. Insert AC input wires according to polarities indicated on terminal block and tighten the terminal screws. Be sure to connect PE protective conductor (⊕) first.

⊕ → **Ground (yellow-green)**
L → **LINE (brown or black)**
N → **Neutral (blue)**

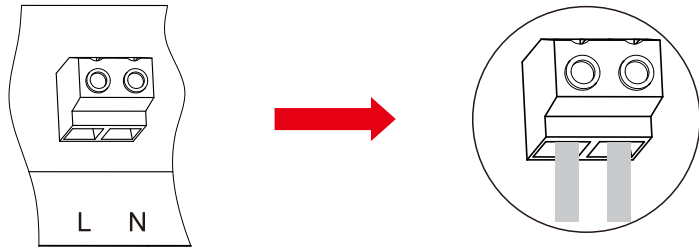
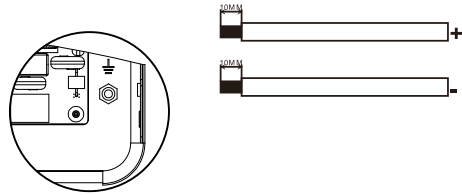

WARNING: Be sure that AC power source is disconnected before attempting to hardwire it to the unit.

4. Then, insert AC output wires according to polarities indicated on terminal block and tighten terminal screws. Be sure to connect PE protective conductor (⊕) first.

⊕ → **Ground (yellow-green)**
L → **LINE (brown or black)**
N → **Neutral (blue)**

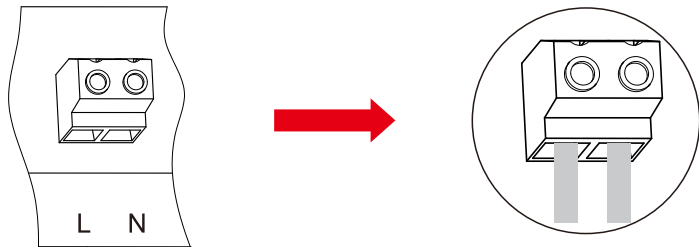
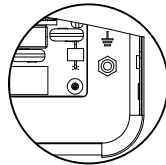

5. Make sure the wires are securely connected.

CAUTION: Important

Be sure to connect AC wires with correct polarity. If L and N wires are connected reversely, it may cause utility short-circuited when these inverters are worked in parallel operation.

CAUTION: Appliances such as air conditioner are required at least 2~3 minutes to restart because it's required to have enough time to balance refrigerant gas inside of circuits. If a power shortage occurs and recovers in a short time, it will cause damage to your connected appliances. To prevent this kind of damage, please check manufacturer of air conditioner if it's equipped with time-delay function before installation. Otherwise, this inverter/charger will trig overload fault and cut off output to protect your appliance but sometimes it still causes internal damage to the air conditioner.

PV Connection

CAUTION: Before connecting to PV modules, please install separately a DC circuit breaker between inverter and PV modules.

WARNING! All wiring must be performed by qualified personnel.

WARNING! It's very important for system safety and efficient operation to use appropriate cable for PV module connection. To reduce risk of injury, please use the proper recommended cable size as below.

Model	Cable Size	Cable (mm ²)	Torque
1.8KVA	10AWG	6	1.2Nm
3.6KVA	10AWG	6	1.2Nm

PV Module Selection:

When selecting proper PV modules, please be sure to consider below parameters:

1. Open circuit Voltage (Voc) of PV modules not exceeds max. PV array open circuit voltage of inverter.
2. Max. power voltage (Vmp) should be during PV array MPPT voltage range.

Solar Charging Mode		
INVERTER MODEL	1.8KVA	3.6KVA
Max. PV Array Open Circuit Voltage	130V	145V
PV Array MPPT Voltage Range	15-120V	30-120V

Please follow below steps to implement PV module connection:

1. Remove insulation sleeve 10 mm for positive and negative conductors.
2. Check correct polarity of connection cable from PV modules and PV input

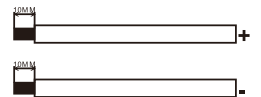

connectors. Then, connect positive pole (+) of connection cable to positive pole (+) of PV input connector. Connect negative pole (-) of connection cable to negative pole (-) of PV input connector.



3. Make sure the wires are securely connected.

Final Assembly

After connecting all wirings, please put bottom cover back by screwing two screws as shown below.

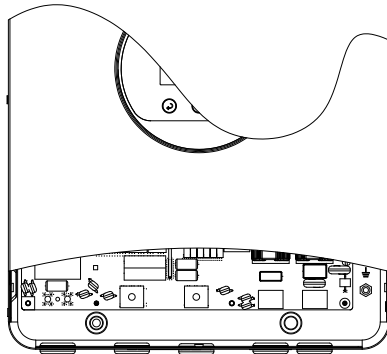

Wiring System for Inverter

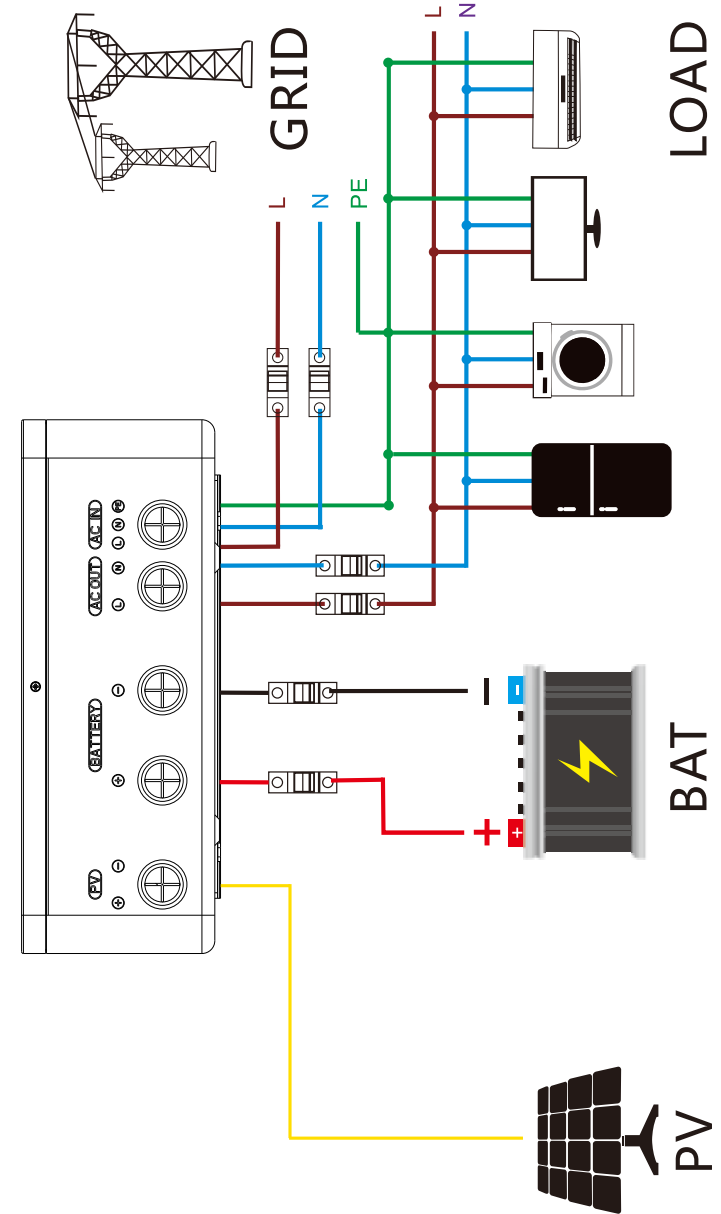

OPERATION Power ON/OFF

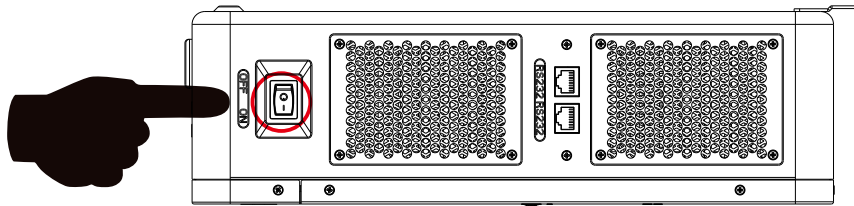

Once the unit has been properly installed and the batteries are connected well, simply press On/Off switch (located on the bottom of the case) to turn on the unit.

Operation and Display Panel

The operation and display panel, shown in below chart, is on the front panel of the inverter. It includes three indicators, Three function keys and a LCD display, indicating the operating status and input/output power information.

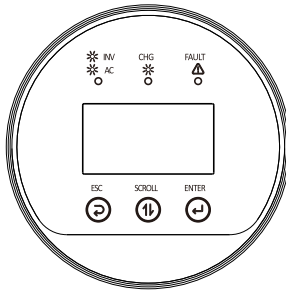

Function Key	Icon	Description
ESC	←	To previous page
SCROLL	↑↓	To go to next selection
ENTER	→	To confirm the selection or go to next page

LED Indicator		Messages	
☀️ AC / ⚡️ INV	Green	Solid On	Output is powered by utility in Line mode.
		Flashing	Output is powered by battery or PV in battery mode.
☀️ CHG	Green	Solid On	Battery is fully charged.
		Flashing	Battery is charging.
⚠️ FAULT	Red	Solid On	Fault occurs in the inverter.
		Flashing	Warning condition occurs in the inverter.
Buzzer Information			
Buzzer beep	Press any button, the buzzer will last for 0.1s. Hold on the "Enter" button, the buzzer will last for 3s. If in fault event, the buzzer will keep going. if in warning event, the buzzer will beep discontinuous (Check more information on the chapter of "Warning Code Table").		

LCD Display Icons

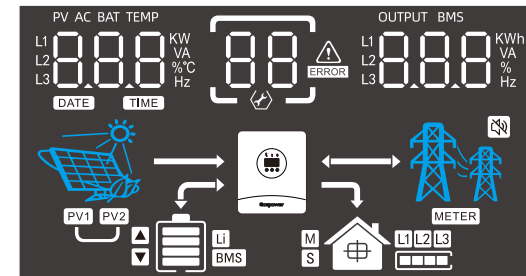

Icon	Function description
Input Source Information	
PV AC BAT TEMP L1 L2 L3 8.8.8 KW VA %C Hz	Indicate input voltage, input frequency, PV voltage, PV power, battery voltage and charger current.
Configuration Program and Fault Information	
8.8 ⚡️	Indicates the setting programs.
8.8 ⚠️ ERROR	Indicates the warning and fault codes. Warning: 8.8 ⚠️ flashing with warning code. Fault: 8.8 ⚠️ lighting with fault code

Output Information	
OUTPUT BMS L1 88.8 KWh L2 88.8 VA L3 88.8 % Hz	Indicate output voltage, output frequency, load percent, load in VA, load in Watt and discharging current.
Battery Information	
	Indicates battery level by 0-24%, 25-49%, 50-74% and 75-100%.
	Indicates Lithium battery type.
	BMS Indicates communication is built between inverter and BMS. ▲ Indicates BMS allows battery discharge. ▼ Indicates BMS allows battery charge. Force charge occurs if icon flash.
Mode Operation Information	
	Indicates the utility charger circuit is working.
	Indicates the inverter/charger is working.
	Indicates PV MPPT is working to power load.
	Indicates PV MPPT is working to charge battery.
	Indicates battery is discharging to load.
Mute Operation	
	Indicates unit alarm is disabled.

LCD operation flow chart

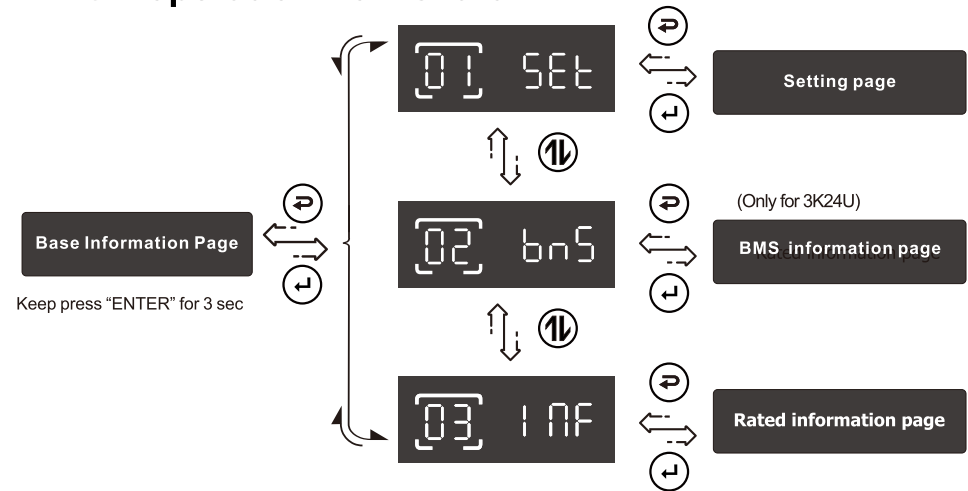

On the base information page, pressing and holding "ENTER" key for 3 sec. The unit parameter page is displayed. Press "SCROLL" to switch to the selected page, and press "ENTER" to go to the selected page. Press "ESC" to return to the previous page.

Base information Page

The base information will be switched by pressing "SCROLL" key. The selectable information is switched as below order:



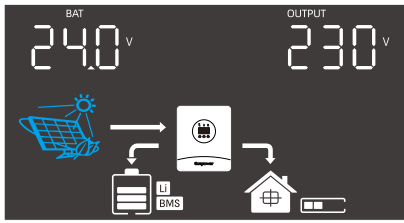
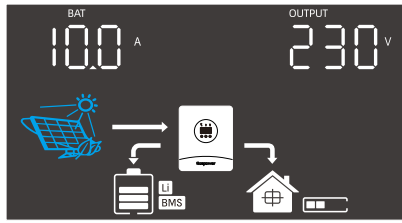
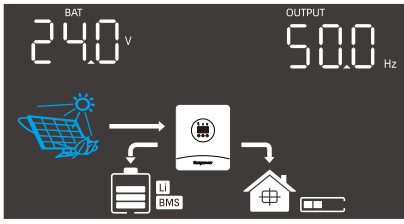
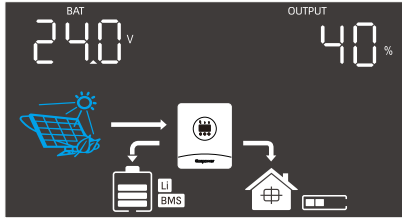
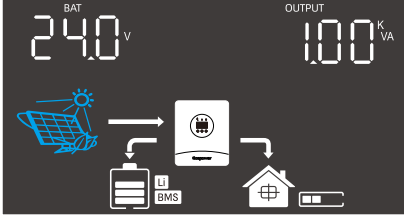
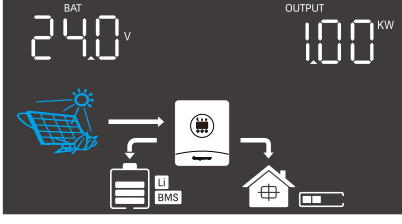
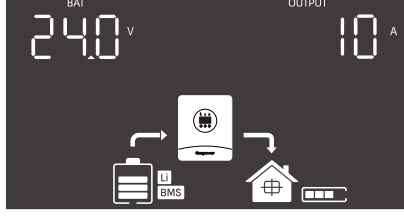











Input voltage / Output voltage Utility voltage is 230V, output voltage is 230V 	Input frequency / Output voltage Utility frequency is 50.0Hz, output voltage is 230V
PV voltage / Output voltage PV voltage is 36 V, output voltage is 230V 	PV power / Output voltage PV power is 1.00kW, output voltage is 230V

<p>Battery voltage / Output voltage Battery voltage is 24.0V, output voltage is 230V</p> 	<p>Charging current / Output voltage Charging current is 10A, output voltage is 230V</p> 
<p>Battery voltage / Output frequency Battery voltage is 24.0V, output frequency is 50.0Hz</p> 	<p>Battery voltage / Load percentage Battery voltage is 24.0V, load percentage is 40%</p> 
<p>Battery voltage / Load VA Battery voltage is 24.0V, output wattage is 1.00kVA</p> 	<p>Battery voltage / Load wattage Battery voltage is 24.0V, output wattage is 1.00kW</p> 
<p>Battery voltage / Output current Battery voltage is 24.0V, output current is 10A</p> 	

Setting Page

Press "SCROLL" button to select setting programs. And then, press "ENTER" button to confirm the selection or ESC button to exit. Press and hold the "SCROLL" key for 3 seconds to continuously switch pages.

Setting items:

		Selectable option		
00	Exit setting		ESC	
01	Battery type setting	AGM	Default	If "Self-defined" or "Lib" is selected battery charge voltage and low DC cut-off voltage can be set up in program 03,04 and 05 If "Lib" is selected, inverter can charge Lithium battery when the Lithium battery need to be activated. Please make sure Lithium battery is connected before you start up inverter. If inverter doesn't connect battery or Lithium battery, do not select "Lib" battery type.
		bAt 	AGn	
		Flooded	Default	
		bAt 	FLd	
		self-defined	Default	
		bAt 	USE	
		Lib	Default	
		bAt 	LIb	
02	BMS Type (Only for 3K24U)		Default	The default is the Gospower protocol. If the battery type is customized or lithium battery, select the protocol based on the actual battery pack. If selected, the protocol is the PYLONTECH protocol. If the battery type is customized or lithium battery, select the protocol based on the actual battery pack.
		bns 	0	
		bns 	BMS	
03	Bulk charging voltage setting (C.V voltage)	24V model	Default	If "self-defined" or "Lib" is selected in program 01, this program is enabled. Setting range is from 24.0V to 30.0V.
		Cv 	28.2 v	
		12V model	Default	If "self-defined" or "Lib" is selected in program 01, this program is enabled. Setting range is from 12V to 14.5V.
		Cv 	14.1 v	
04	Floating charging voltage	24V model	Default	If "self-defined" or "Lib" is selected in program 01, this program is enabled. Setting range is from 24.0V to 30.0V.
		FLv 	27.0 v	
		12V model	Default	If "self-defined" or "Lib" is selected in program 01, this program is enabled. Setting range is from 12V to 13.5V.
		FLv 	13.5 v	
05	Low DC cut-off voltage or SOC	24V model	Default	If "self-defined" or "Lib" is selected in program 01, this program is enabled. Setting range is from 21.0V to 27.0V.
		bCv 	21.0 v	
		12V model	Default	
bCv 	10.5 v			
		24V model	Default	If the battery type is lithium battery and BMS communication succeeded the set value will change to SOC Setting range is from 0% to 90%.
		bCv 	0 %	

06	Setting battery voltage or SOC point back to utility when selecting "SBU priority" in program 24	24V model 6U4 06	Default 240 ^v	Setting range is from 22.0V to 27.0V. Increment of each click is 0.1V.
		12V model 6U4 06	Default 115 ^v	Setting range is from 11V-13.5V. Increment of each click is 0.1V.
		24V model 6U4 06	Default 10 %	If the battery type is lithium battery and BMS communication succeeded the set value will change to SOC Setting range is from 5% to 95%.
07	Setting battery voltage point back to battery mode when selecting "SBU priority" in program 24	24V model 664 07	Default 270 ^v	Setting range is from 24.0V to 30.0V. Increment of each click is 0.1V.
		12V model 664 07	Default 135 ^v	Setting range is from 12V-14.5V. Increment of each click is 0.1V.
		24V model 664 07	Default 30 %	If the battery type is lithium battery and BMS communication succeeded the set value will change to SOC Setting range is from 10% to 100%.
09	Max charging current (Utility charge current + PV charging current)	60A 6CC 09	Default 120 ^A	Setting range is from 2A to 105A/120A. Increment of each click is 1A.
10	Max utility charging current setting	30A CHC 10	Default 60 ^A	Setting range is from 2A to 60A. Increment of each click is 1A.
21	Output voltage setting	220V 0PU 21	Default 220 ^v	Output voltage configuration.
		220V 0PU 21	Default 230 ^v	
		220V 0PU 21	Default 240 ^v	
22	Output frequency setting	50Hz 0PF 22	Default 50 ^{Hz}	Output frequency configuration.
		60Hz 0PF 22	60 ^{Hz}	
23	Utility input range setting	Appliance mode AC 23	Default APL	APL should be selected, when the utility is not well.
		UPS mode AC 23	UPS	

24	Output source priority	Utility >> PV >> Battery 0PS 24 USB	Default	Utility provides power to the loads first. PV and battery will provide power to loads only when utility is not available.	
		PV >> Utility >> Battery 0PS 24 SUB	Default	PV provides power to the loads first. If PV is not sufficient, utility will supply power the loads at the same time. Battery will provide power to loads only when utility is not available.	
		PV >> Battery >> Utility 0PS 24 SBU	Default	PV provides power to the loads first If PV is not sufficient, battery will supply power to the loads at the same time. Utility provides power to the loads only when battery voltage drops to the setting point in program 6.	
25	Charger priority	If inverter is working in utility mode, charger priority can be set as below. However, when inverter is working in Battery mode, only PV can charge battery.			
		PV First CHS 25	Default CSO	PV will charge battery first. Utility will charge battery only when PV is unavailable.	
		PV and Utility CHS 25	SNU	PV and utility will charge battery together.	
27	Overload bypass function	Disable LBP 27	Default DIS	If it is enabled, the inverter will switch to utility mode if overload happens in battery mode.	
		Enable LBP 27	ENR		
28	Overload restart function	Disable OLT 28	Default DIS	If it is enabled, the inverter will auto restart when overload occurs.	
		Enable OLT 28	ENR		





29	Over temperature restart function	Disable	29	Default	If it is enabled, the inverter will auto restart when over temperature occurs.
		0Et	29	d1 S	
40	Backlight of LCD	Disable	40	Default	If selected, LCD backlight will be off after no button is pressed for 60s.
		bL	40	d1 S	
41	Auto return to the first page of display screen	Disable	41	Default	If selected, the display screen will stay at latest screen user finally switches.
		bFP	41	d1 S	
42	Buzzer Alarm	Disable	42	Default	If selected, buzzer is not allowed to beep.
		bEP	42	d1 S	
44	Reset Default	Disable	44	Default	If selected, default initial Settings page.
		rSt	44	d1 S	
45	Fan Work Mode	FAN	45	Default	In performance mode, the inverter will perform at its highest performance.
		FAN	45	PFC	Balanced mode, applicable to the condition of 80% output power and 90A charge current limitation, to reduce additional noise greatly.
		FAN	45	SIL	Silent mode, applicable to the condition of 60% output power and 70A charge current limitation, to reduce additional noise extremely.

Note:

- 1) The setting value of item "07" should be larger than the setting value of item "06".
- 2) Please turn off the "ON/OFF switch" to save the settings.



BMS information Page (Only for 3K24U)

The BMS information will be switched by pressing "SCROLL" key. The selectable information is switched as below order:

<p>Battery pack number / mean SOC Connected battery pack number is 1, mean SOC is 97%</p> 	
<p>BMS voltage / SOC BMS voltage is 24.0V, SOC is 99% on battery pack of address 1</p> 	<p>BMS voltage / current BMS voltage is 24.0V, current is 1A on battery pack of address 1</p> 
<p>BMS highest temperature / lowest temperature BMS highest temperature is 25 °C, lowest temperature is 20 °C on battery pack of address 1</p> 	<p>BMS fault code / flag BMS fault code is 0, flag is 000 on battery pack of address 1</p> 

Rated information Page

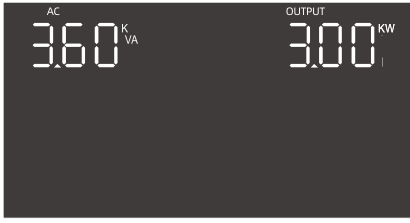
The rated information will be switched by pressing "SCROLL" key. The selectable information is switched as below order:

<p>Rated VA / WATT Rated VA is 3.60kVA, WATT is 3.00kW</p> 	<p>Rated battery voltage / Max. charge current Rated battery voltage is 24V, Max. charge current is 120A</p> 
<p>Firmware version Firmware version is 1400</p> 	

Lithium Battery Communication

It's allowed to connect lithium battery and build communication only which it has been configured. Please follow below steps to configure communication between lithium battery and inverter.

1. Connect power cables between lithium battery and inverter. Please pay attention to the terminals of positive and negative. Make sure the positive terminal of battery is connected to the positive terminal of inverter, and the negative terminal of battery is connected to the negative terminal of inverter.
2. The communication cable is bundled with lithium battery. Both sides are RJ45 port. One port is connected to the BMS port of inverter and another one is connected to the COMM port of lithium battery.

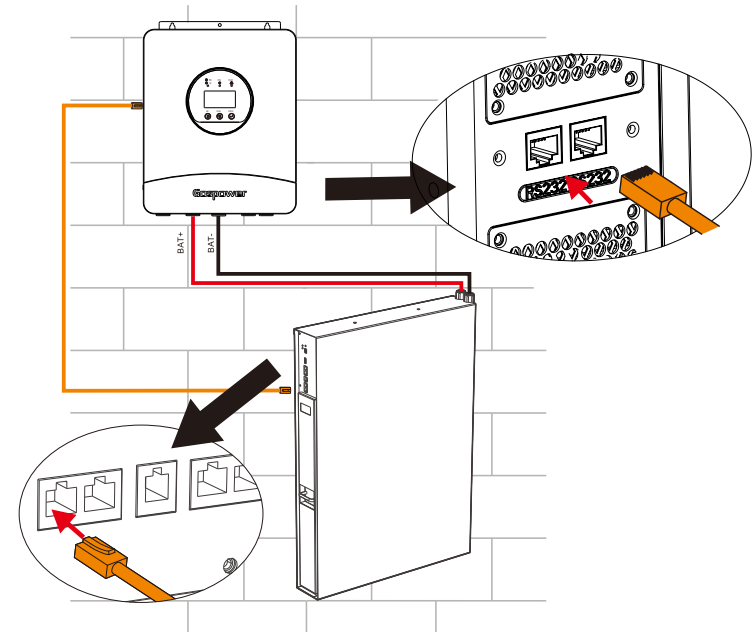

3. Configure battery type to "Lib" in LCD setting No.01.

The battery type is Lib

bAt [Li] b

And then LCD will show you "Li" icon.

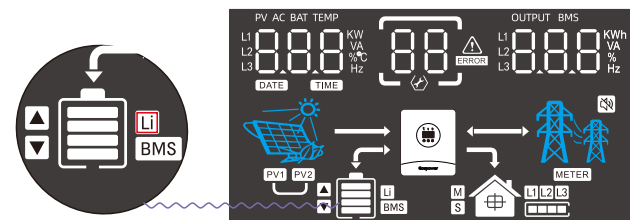

4. Power up lithium battery and inverter. Wait a moment, if the communication is built between them, LCD will show you "BMS" icon as below.

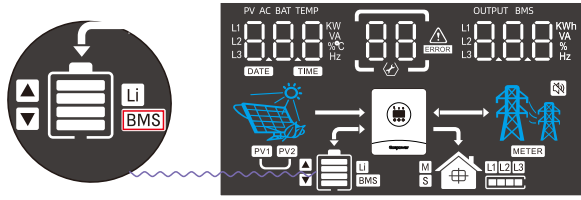

5. Roll LCD real time information pages by pressing "SCROLL" button, as below page, you can see the parameters of SOC in the communication system.

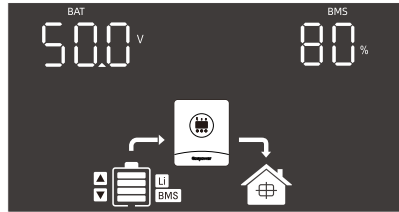

This page means SOC is 80%.

Warning Code Table

When fault event happens, the fault LED is flashing. At the same time, warning code, icon  is shown on the LCD screen.

Warning Code	Warning Information	Audible Alarm	Trouble Shooting
1	Over-load warning	Beep twice every second	Reduce the loads.
4	Grid over-voltage warning	Beep three times every second	
21	Over-temperature warning	Beep three times every second	Check if the Fans wiring connected well. Replace the fan.Reduce the loads
22	Vbus over threshold value warning		AC Surge or internal components failed. Restart the unit, if the error happens again, please return to repair center.

Fault Code Table

When fault event happens, inverter will cut off output, and the fault LED is solid on. At the same time, fault code, icon

 and **ERROR** are shown on the LCD screen.

Fault Code	Fault information	Trouble Shooting
01	Bus voltage is too high	AC Surge or internal components failed. Restart the unit, if the error happens again, please return to repair center.
02	Bus voltage is too low	Restart the unit, if the error happens again, please return to repair center.
13	Output voltage is too low	Reduce the connected load. Restart the unit, if the error happens again, please return to repair center.
14	Output voltage is too high	Restart the unit, if the error happens again, please return to repair center.
15	Output short circuited	Check if wiring is connected well and remove abnormal load.
20	Overload time out	Reduce the connected load by switching off some equipment.
23	Ac input-output reverse connection	1. Please check AC input and output wires are connected correctly. 2. If this error happens during parallel installation, please check wires connection. If they are connected correctly, please finish parallel installation first, and then restart inverters. 3. If the problem remains, please contact your installer.
30	Battery voltage is too high	Check if spec and quantity of batteries are meet requirements.
36	Over current happen at LLC circuit	Restart the unit, if the error happens again, please return to repair center
40	PV voltage is too high	Reduce the number of PV modules in series.
41	Short circuited happen at PV port	Check if wiring is connected well.
43	Over current happen at PV port	Restart the unit, if the error happens again, please return to repair center.
51	Over temperature happen at PV circuit	The temperature of internal PV component is over the limitation. Check whether the air flow of the unit is blocked or whether the ambient temperature is too high.
52	Over temperature happen at INV circuit	The temperature of internal INV component is over the limitation. Check whether the air flow of the unit is blocked or whether the ambient temperature is too high.
53	Over temperature happen at SR circuit	The temperature of SR battery converter component is over the limitation. Check whether the air flow of the unit is blocked or whether the ambient temperature is too high.

Solar inverter

Fault Code	Fault information	Trouble Shooting
79	BMS communication failed	1. Check if communication cables are connected well and restart the inverter. 2. If the problem remains, please contact your installer.
81	Grid charging bypass over-power	The bypass output power exceeds the normal power, please use electrical equipment with appropriate power.
82	Grid charging input over-current	The input current is too high under charging conditions. Restart the unit, if the error happens again, please return to repair center.
88	Grid charging output short-circuit	Short circuit occurred in the output under charging conditions, please check if wiring is connected well and remove abnormal load.
89	Grid charging output under-voltage	Under charging conditions, the output voltage is low. Restart the unit, if the error happens again, please return to repair center.
90	Grid charging output over-voltage	Under charging conditions, the output voltage is high. Restart the unit, if the error happens again, please return to repair center.
91	Grid charging output over-power	The input power of the battery is too high during charging, please use electrical equipment with appropriate power.
93	Push-pull bus over-voltage	When discharging, the bus voltage is higher than the normal operating voltage. Restart the unit, if the error happens again, please return to repair center.
94	Push-pull bus under-voltage	When discharging, the bus voltage is lower than the normal operating voltage. Restart the unit, if the error happens again, please return to repair center.
96	PV output over-power	Under PV conditions, the output power is higher than the normal power range, please use electrical equipment with appropriate power.
97	PV output over-voltage	Under PV conditions, the output voltage is higher than normal. Restart the unit, if the error happens again, please return to repair center.
98	PV output under-voltage	Under PV conditions, the output voltage is lower than normal. Restart the unit, if the error happens again, please return to repair center.
99	Temperature rise too fast protection	The inverter is heating up too fast. Check whether the air flow of the unit is blocked or whether the ambient temperature is too high.